

Serial / System Bootloader

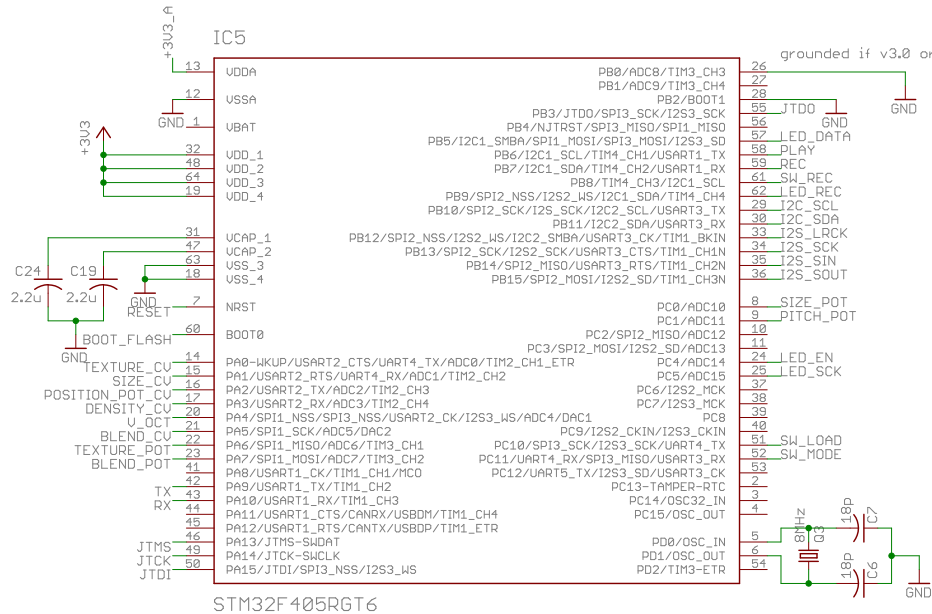

STM32F405RGT6

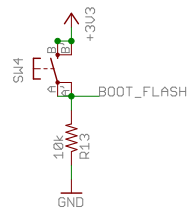
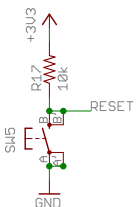
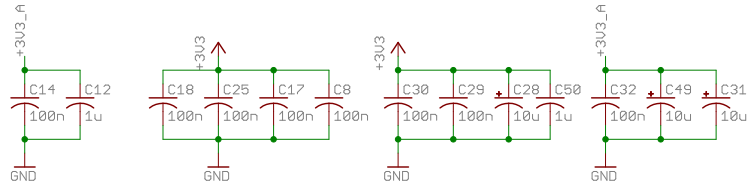
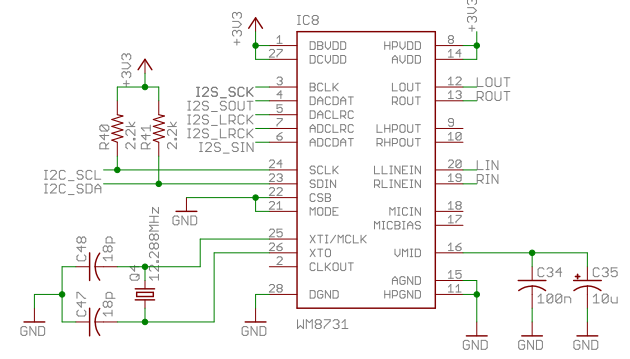

cc-by-sa	Main processor
Émilie Gillet	clouds_v30
emilie.o.gillet@gmail.com	02/04/2019 22:05
	Sheet: 1/4

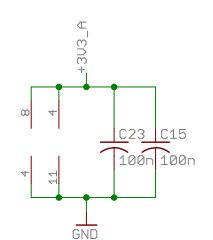
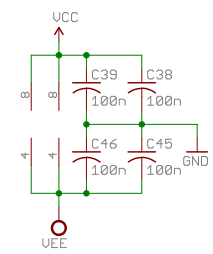
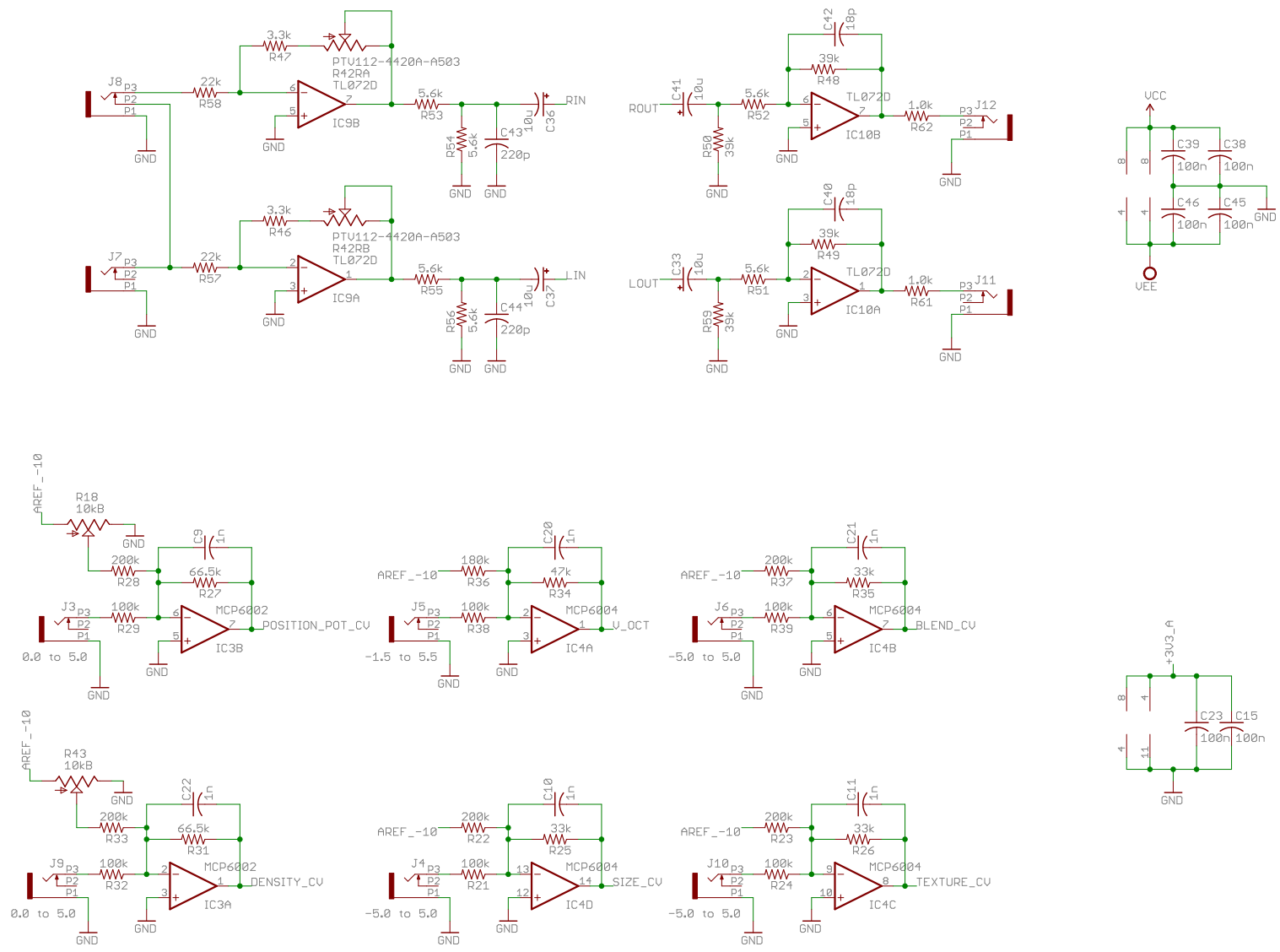

cc-by-sa Émilie Gillet emilie.o.gillet@gmail.com	Audio and CV I/O
	clouds_v30
	02/04/2019 22:05
	Sheet: 2/4

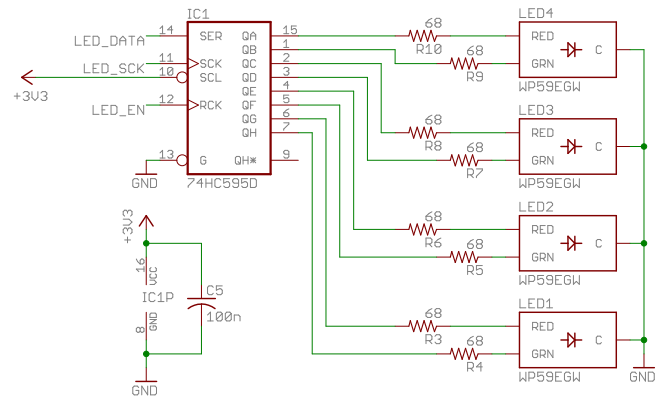
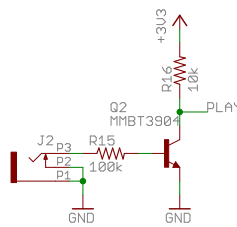
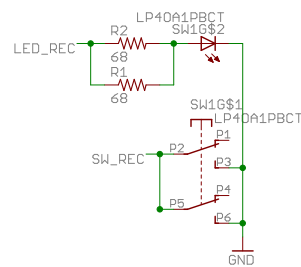
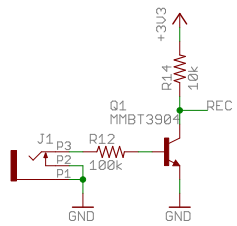
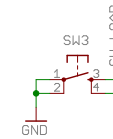
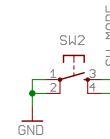
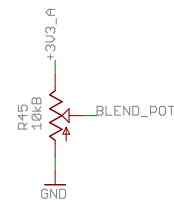
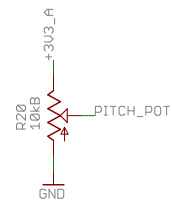
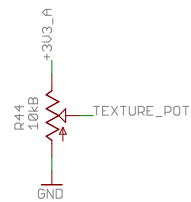
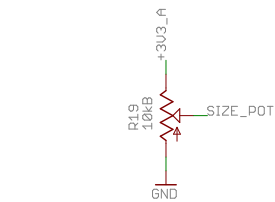

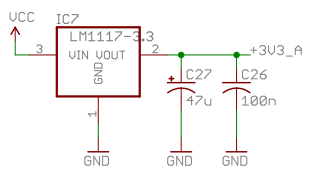
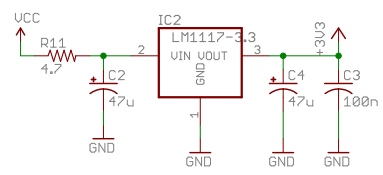
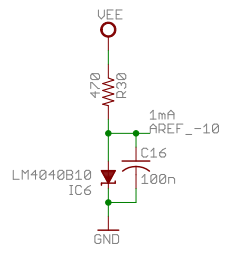
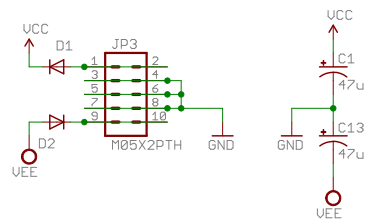

cc-by-sa	Supply
Émilie Gillet	clouds_v30
emilie.o.gillet@gmail.com	02/04/2019 22:05
	Sheet: 4/4